

GREENVILLE AWNING CO.
GHRC-100



① Canopy Isometric View



GHRC-100

SCALE:N/A	APPROVED BY:	DRAWN BY: ES
DATE: 4/23/19		REVISION:
FOR:		Drawing Number: 1 of 13

THESE DRAWINGS WERE PREPARED BY AND ARE THE SOLE PROPERTY OF GREENVILLE AWNING COMPANY. UNAUTHORIZED USE OR REPRODUCTIONS IS STRICTLY PROHIBITED. GREENVILLE AWNING COMPANY ©

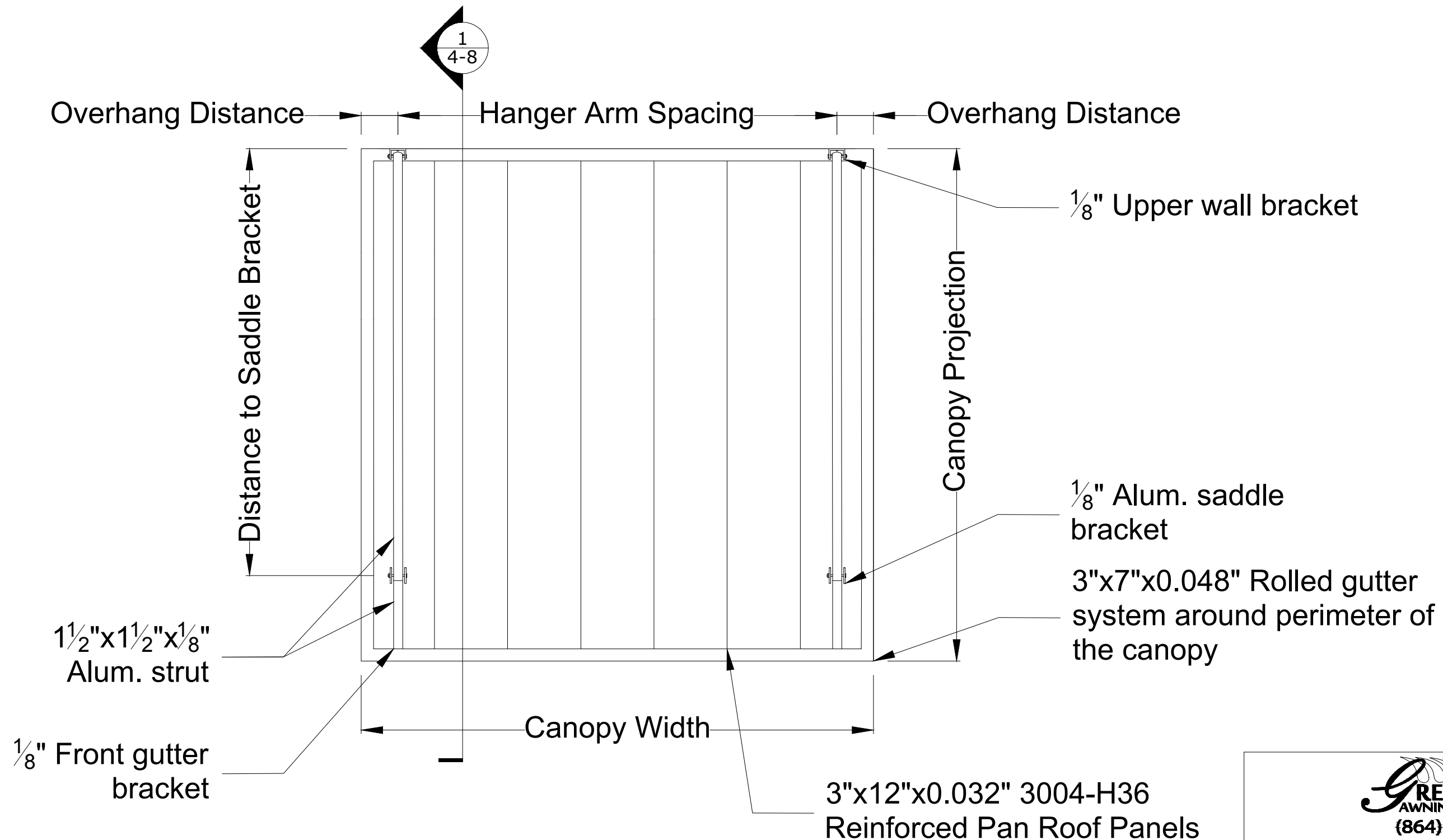

1/2 Canopy Plan View



GHRC-100

SCALE: N/A	APPROVED BY:	DRAWN BY: ES
DATE: 4/23/19		REVISION:
FOR:		Drawing Number: 2 of 13

THESE DRAWINGS WERE PREPARED BY AND ARE THE SOLE PROPERTY OF GREENVILLE AWNING COMPANY. UNAUTHORIZED USE OR REPRODUCTIONS IS STRICTLY PROHIBITED. GREENVILLE AWNING COMPANY ©

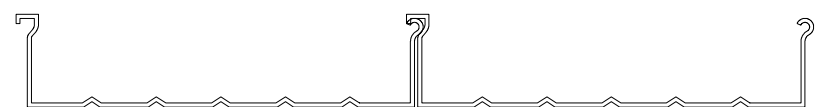
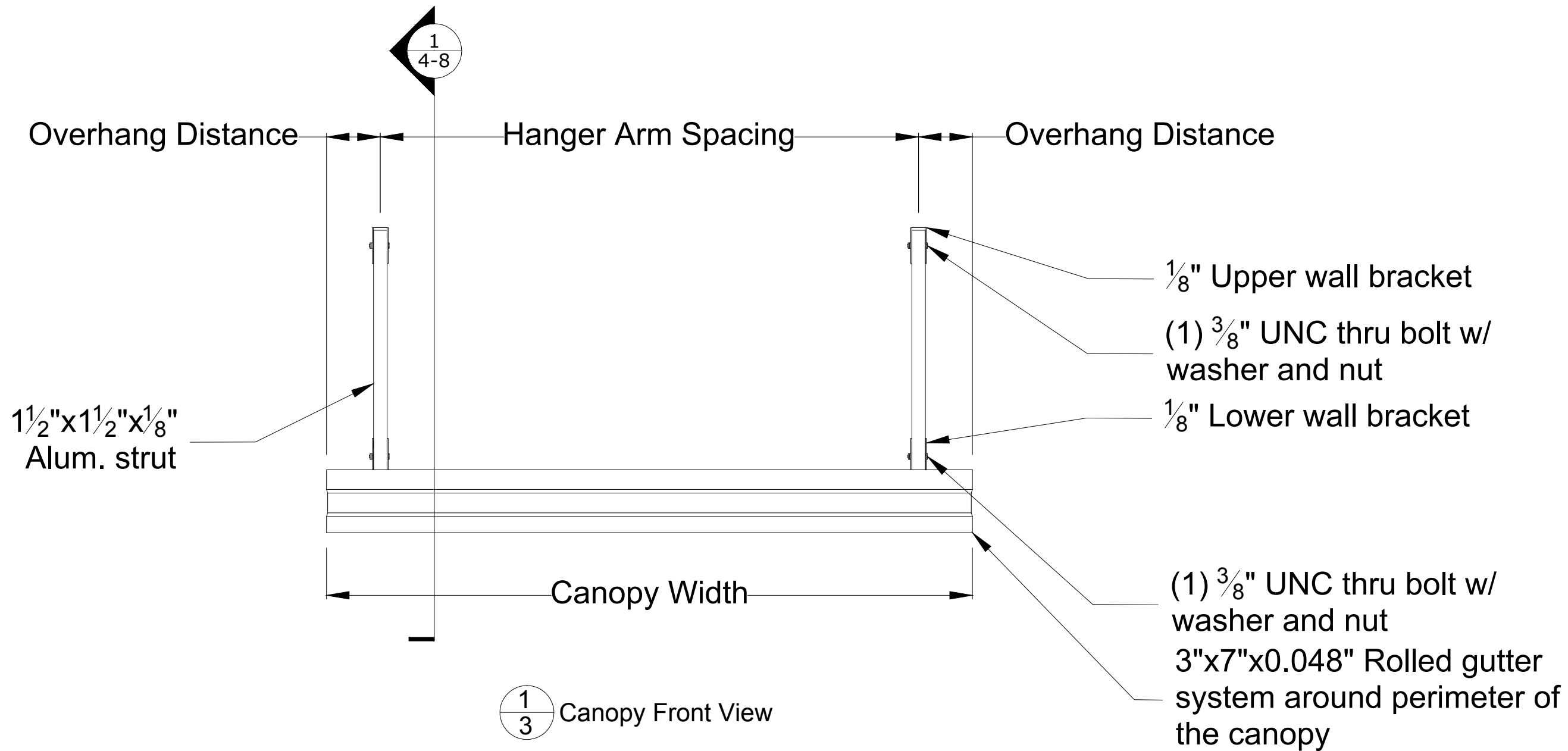

3"x12"x.032" 3004-H36 Reinforced Pan Roof Panels

2/3 Decking Detail



GHRC-100

SCALE:N/A	APPROVED BY:	DRAWN BY: ES
DATE: 4/23/19		REVISION:
FOR:		Drawing Number: 3 of 13

THESE DRAWINGS WERE PREPARED BY AND ARE THE SOLE PROPERTY OF GREENVILLE AWNING COMPANY. UNAUTHORIZED USE OR REPRODUCTIONS IS STRICTLY PROHIBITED. GREENVILLE AWNING COMPANY ©

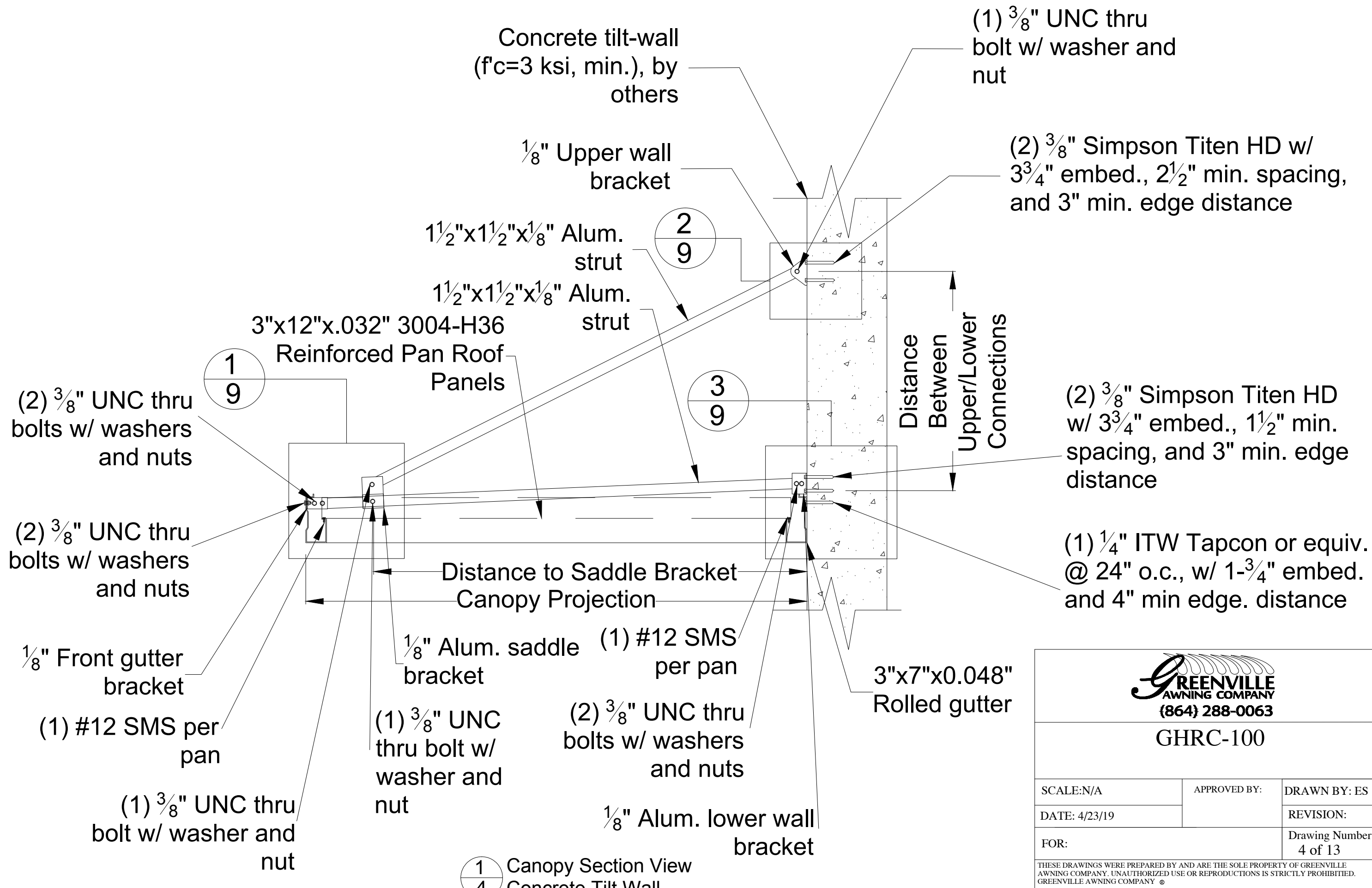

1 Canopy Section View
4 Concrete Tilt Wall



GHRC-100

SCALE:N/A	APPROVED BY:	DRAWN BY: ES
DATE: 4/23/19		REVISION:
FOR:		Drawing Number: 4 of 13
<small>THESE DRAWINGS WERE PREPARED BY AND ARE THE SOLE PROPERTY OF GREENVILLE AWNING COMPANY. UNAUTHORIZED USE OR REPRODUCTIONS IS STRICTLY PROHIBITED. GREENVILLE AWNING COMPANY ©</small>		

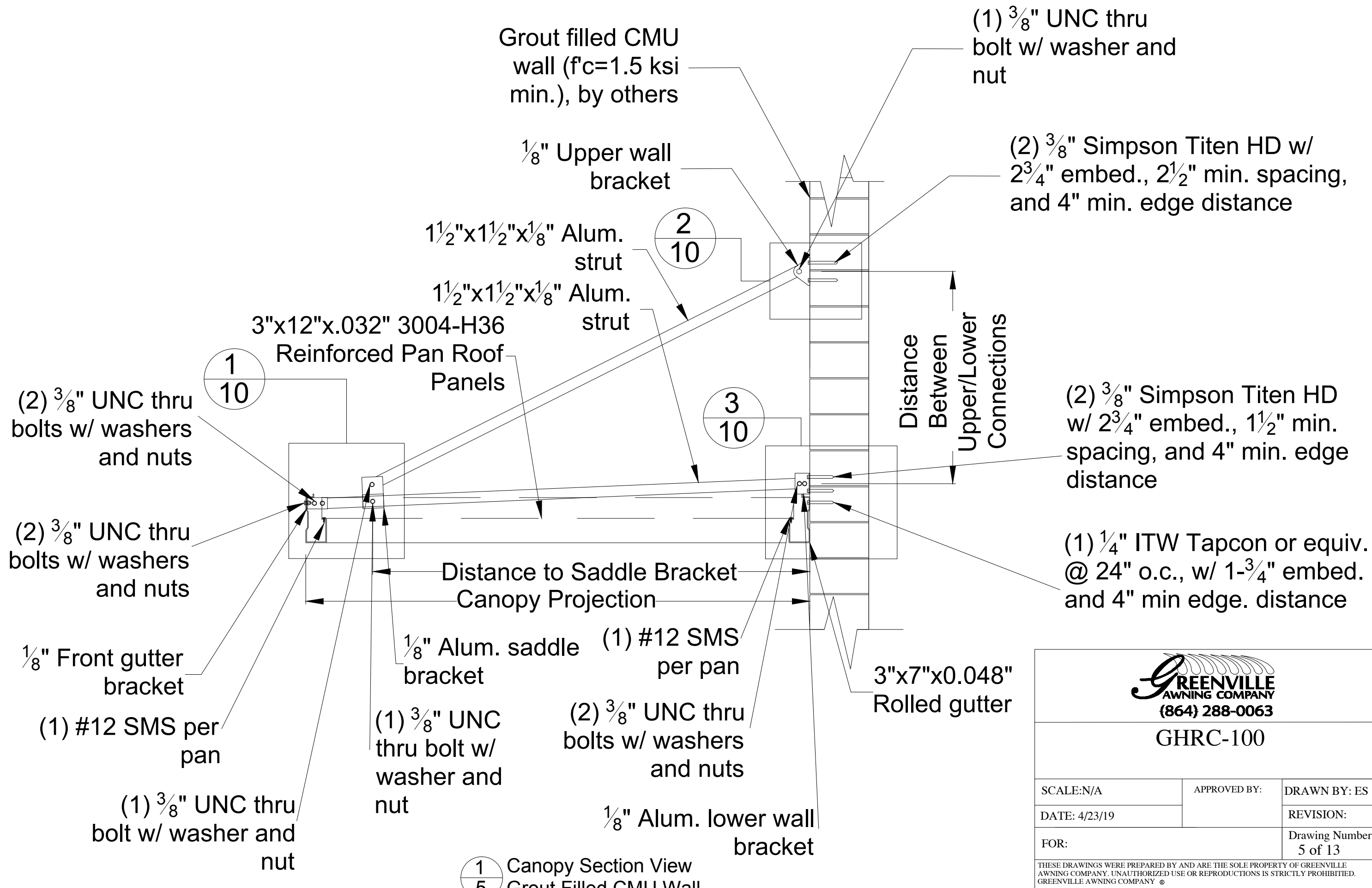

1 Canopy Section View
5 Grout Filled CMU Wall



GHRC-100

SCALE:N/A	APPROVED BY:	DRAWN BY: ES
DATE: 4/23/19		REVISION:
FOR:	Drawing Number: 5 of 13	

THESE DRAWINGS WERE PREPARED BY AND ARE THE SOLE PROPERTY OF GREENVILLE AWNING COMPANY. UNAUTHORIZED USE OR REPRODUCTIONS IS STRICTLY PROHIBITED. GREENVILLE AWNING COMPANY ©

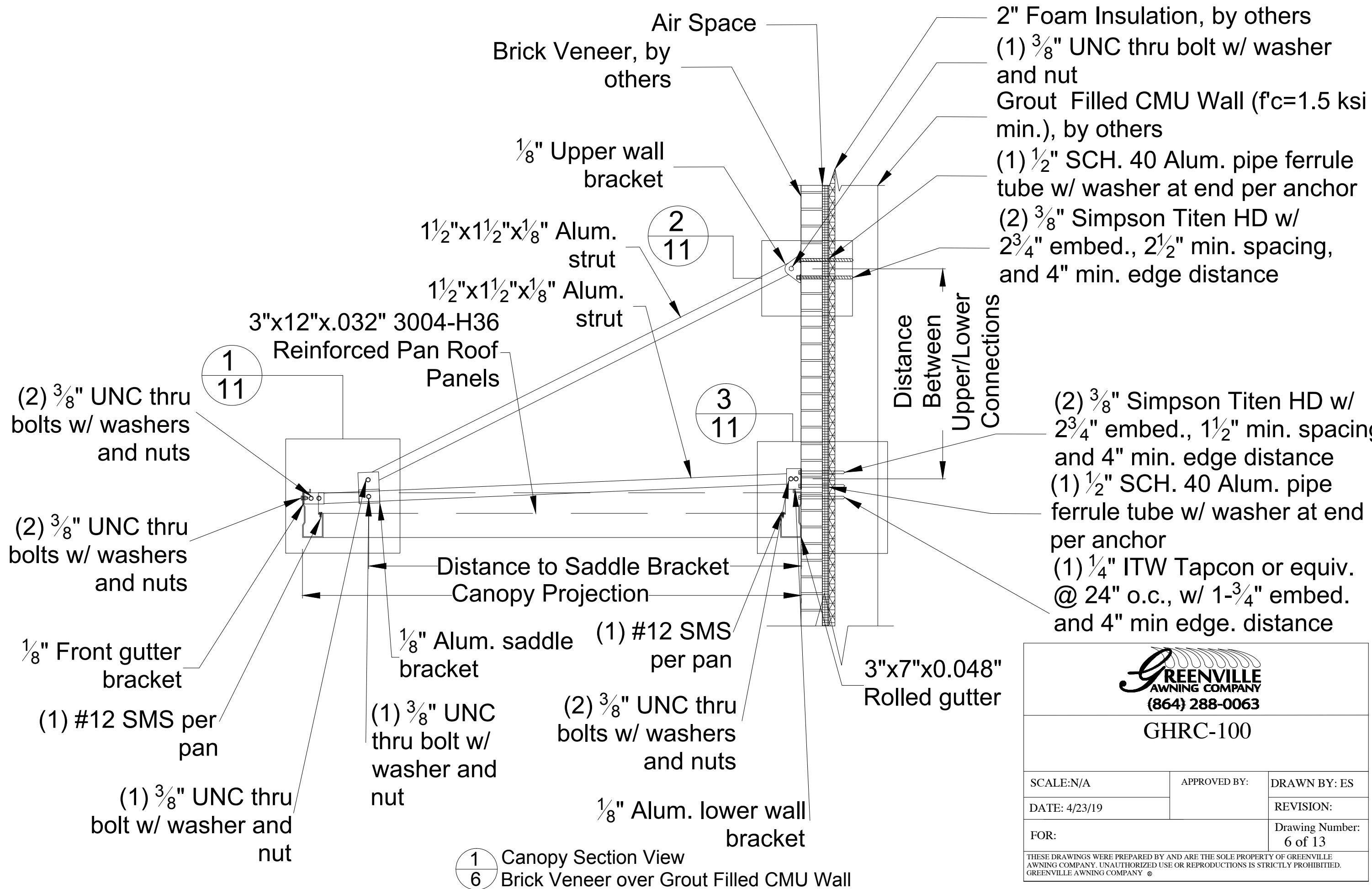

 GREENVILLE AWNING COMPANY (864) 288-0063		
GHRC-100		
SCALE:N/A	APPROVED BY:	DRAWN BY: ES
DATE: 4/23/19		REVISION:
FOR:		Drawing Number: 6 of 13
<small>THESE DRAWINGS WERE PREPARED BY AND ARE THE SOLE PROPERTY OF GREENVILLE AWNING COMPANY. UNAUTHORIZED USE OR REPRODUCTIONS IS STRICTLY PROHIBITED. GREENVILLE AWNING COMPANY ©</small>		

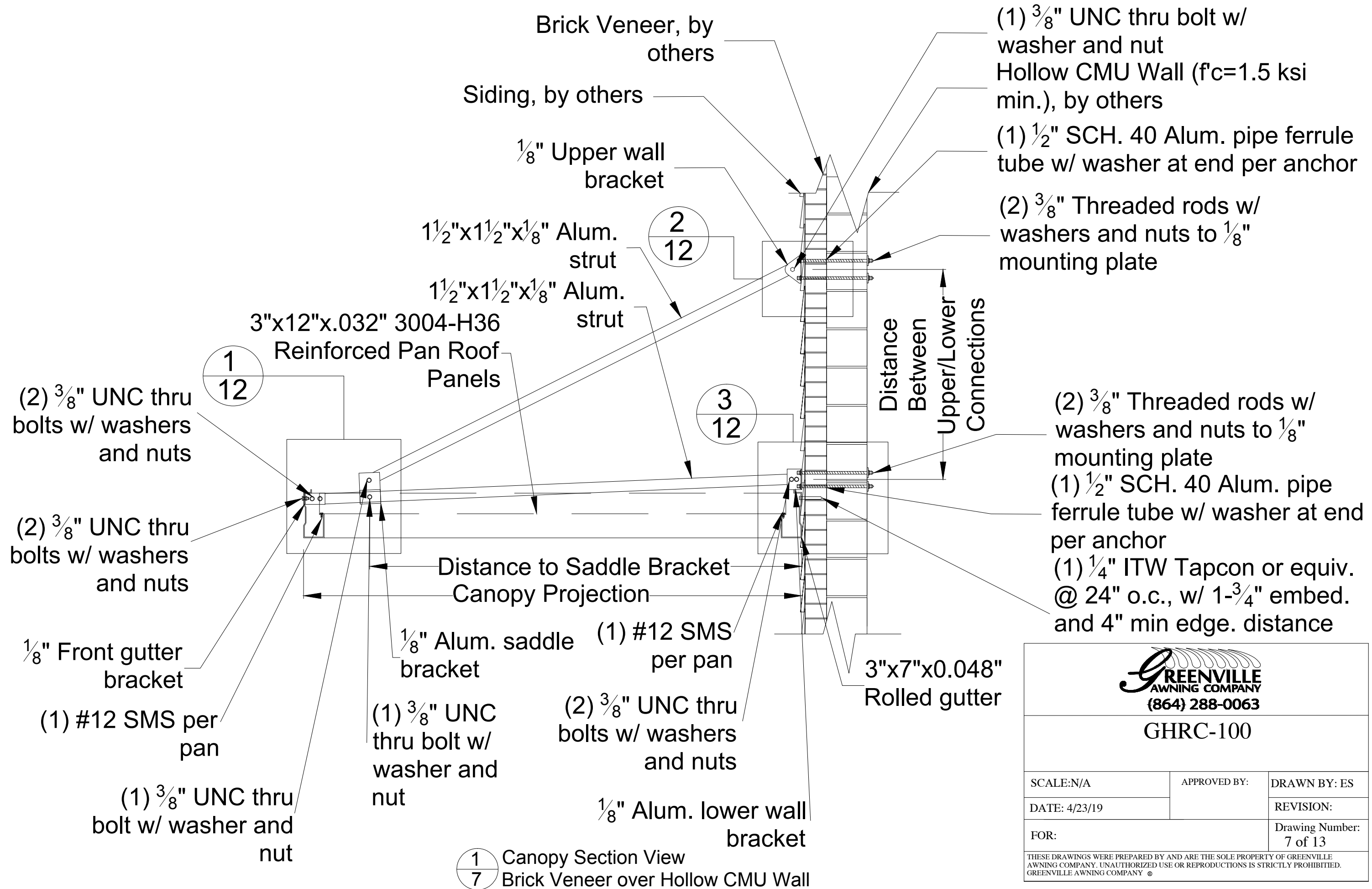

GHRC-100

SCALE:N/A	APPROVED BY:	DRAWN BY: ES
DATE: 4/23/19		REVISION:
FOR:		Drawing Number: 7 of 13

THESE DRAWINGS WERE PREPARED BY AND ARE THE SOLE PROPERTY OF GREENVILLE AWNING COMPANY. UNAUTHORIZED USE OR REPRODUCTIONS IS STRICTLY PROHIBITED. GREENVILLE AWNING COMPANY ©

1 Canopy Section View
7 Brick Veneer over Hollow CMU Wall

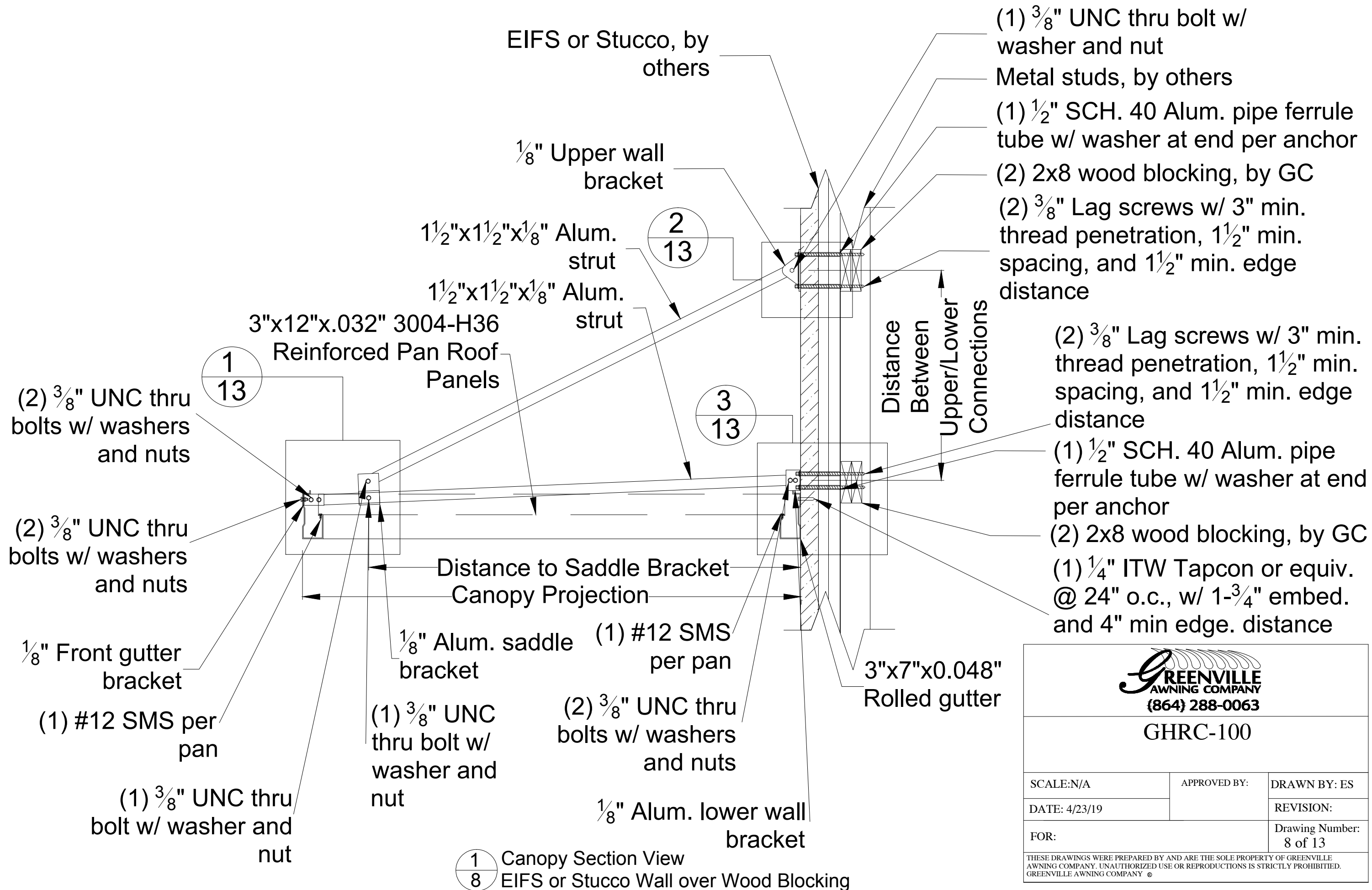

1 Canopy Section View
 8 EIFS or Stucco Wall over Wood Blocking

GREENVILLE
 AWNING COMPANY
 (864) 288-0063

GHRC-100

SCALE: N/A	APPROVED BY:	DRAWN BY: ES
DATE: 4/23/19		REVISION:
FOR:		Drawing Number: 8 of 13
THESE DRAWINGS WERE PREPARED BY AND ARE THE SOLE PROPERTY OF GREENVILLE AWNING COMPANY. UNAUTHORIZED USE OR REPRODUCTIONS IS STRICTLY PROHIBITED. GREENVILLE AWNING COMPANY ©		

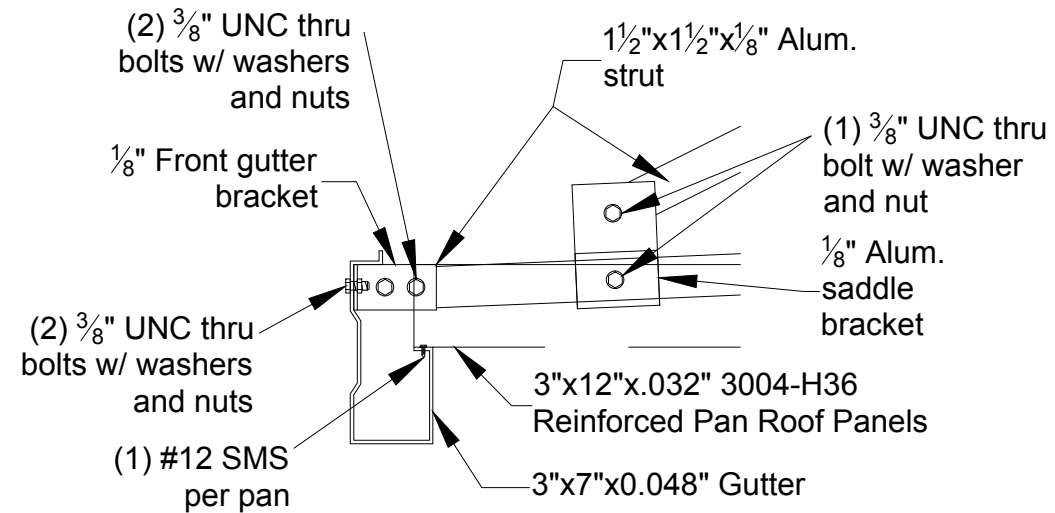

1/9 Front Gutter Detail

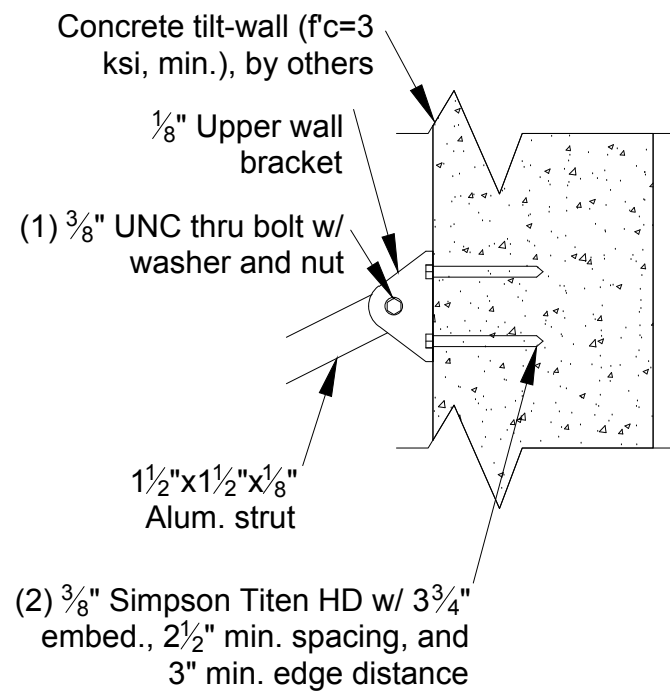

2/9 Wall Bracket Detail

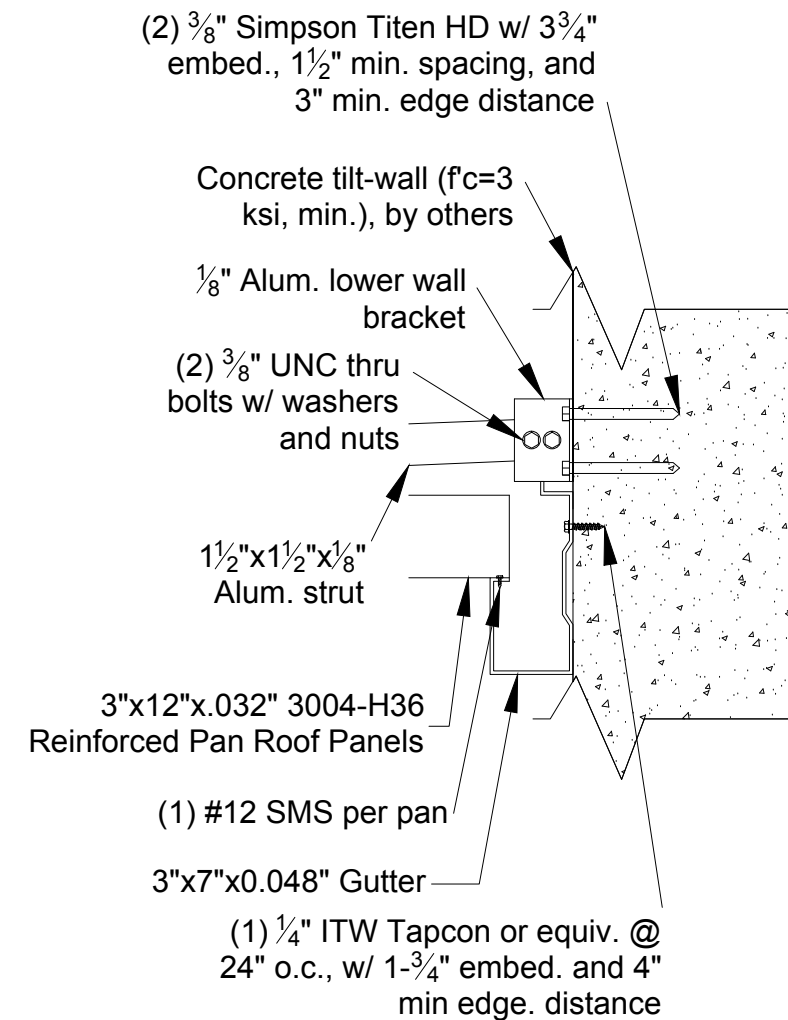

3/9 Rear Gutter Detail

GREENVILLE
AWNING COMPANY
(864) 288-0063

GHRC-100

SCALE:N/A	APPROVED BY:	DRAWN BY: ES
DATE: 4/23/19		REVISION:
FOR:	Drawing Number: 9 of 13	

THESE DRAWINGS WERE PREPARED BY AND ARE THE SOLE PROPERTY OF GREENVILLE AWNING COMPANY. UNAUTHORIZED USE OR REPRODUCTIONS IS STRICTLY PROHIBITED. GREENVILLE AWNING COMPANY ©

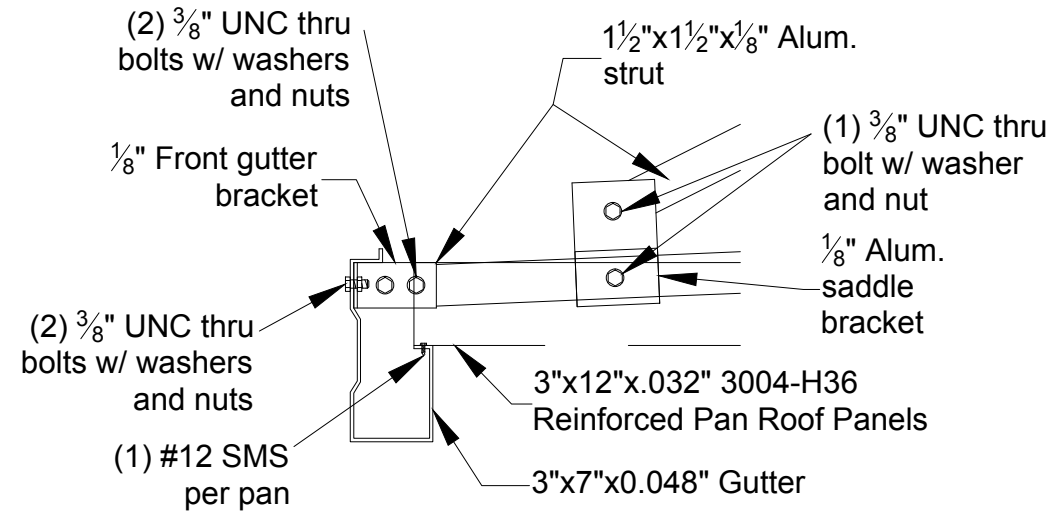

1/10 Front Gutter Detail

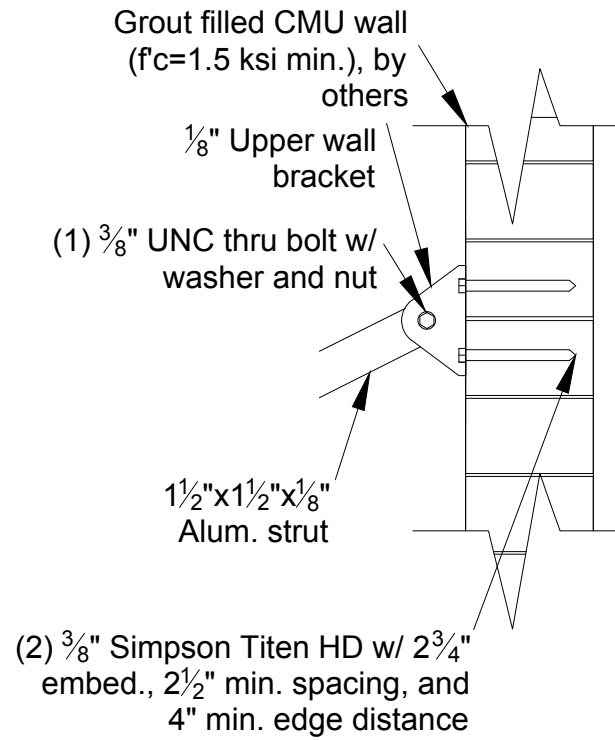

2/10 Wall Bracket Detail

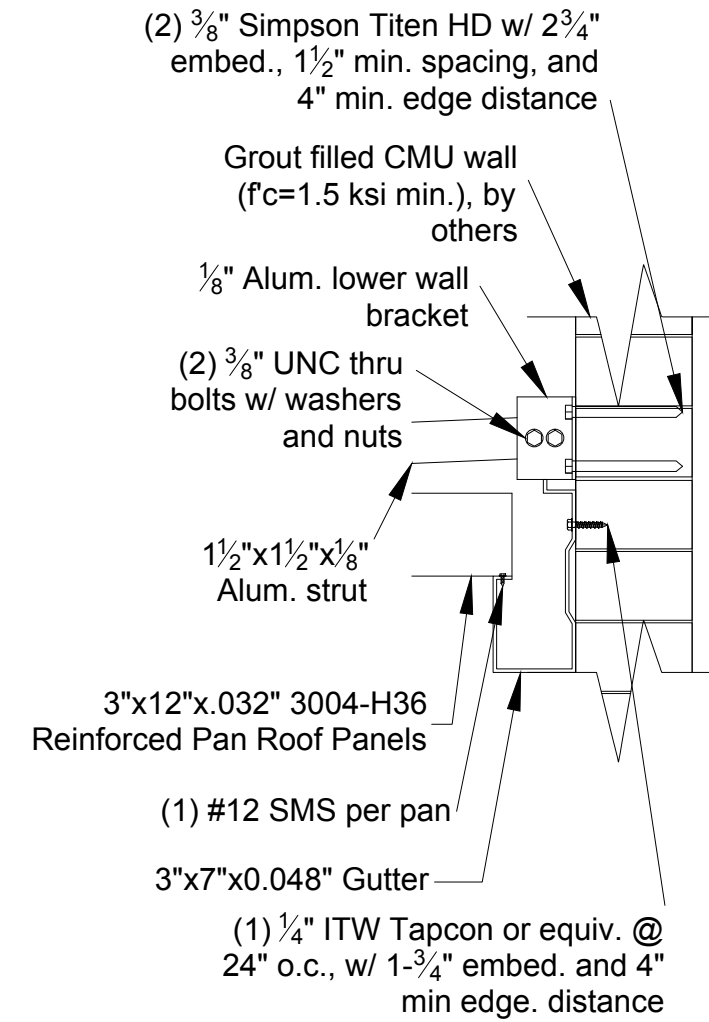

3/10 Rear Gutter Detail



GHRC-100

SCALE:N/A	APPROVED BY:	DRAWN BY: ES
DATE: 4/23/19		REVISION:
FOR:	Drawing Number: 10 of 13	

THESE DRAWINGS WERE PREPARED BY AND ARE THE SOLE PROPERTY OF GREENVILLE AWNING COMPANY. UNAUTHORIZED USE OR REPRODUCTIONS IS STRICTLY PROHIBITED. GREENVILLE AWNING COMPANY ©

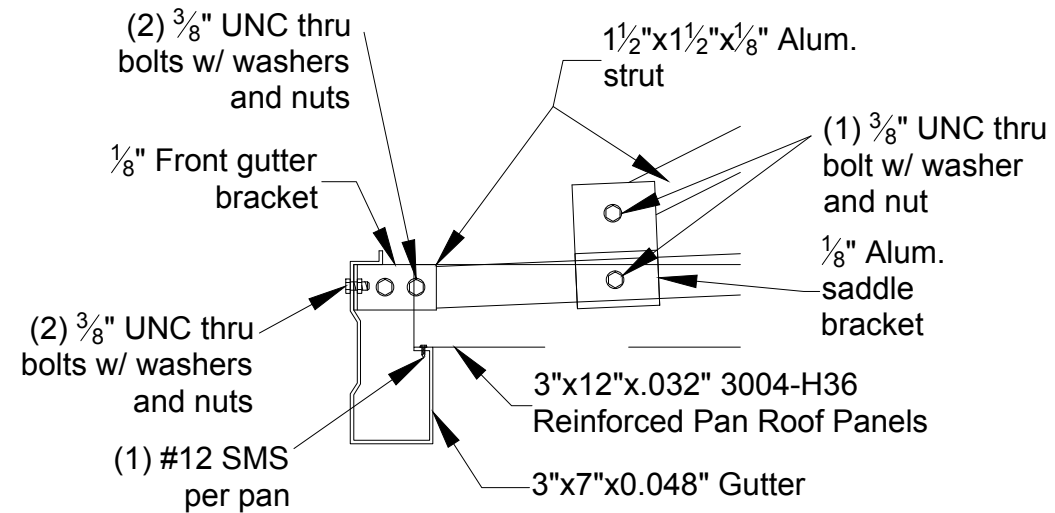

1/11 Front Gutter Detail

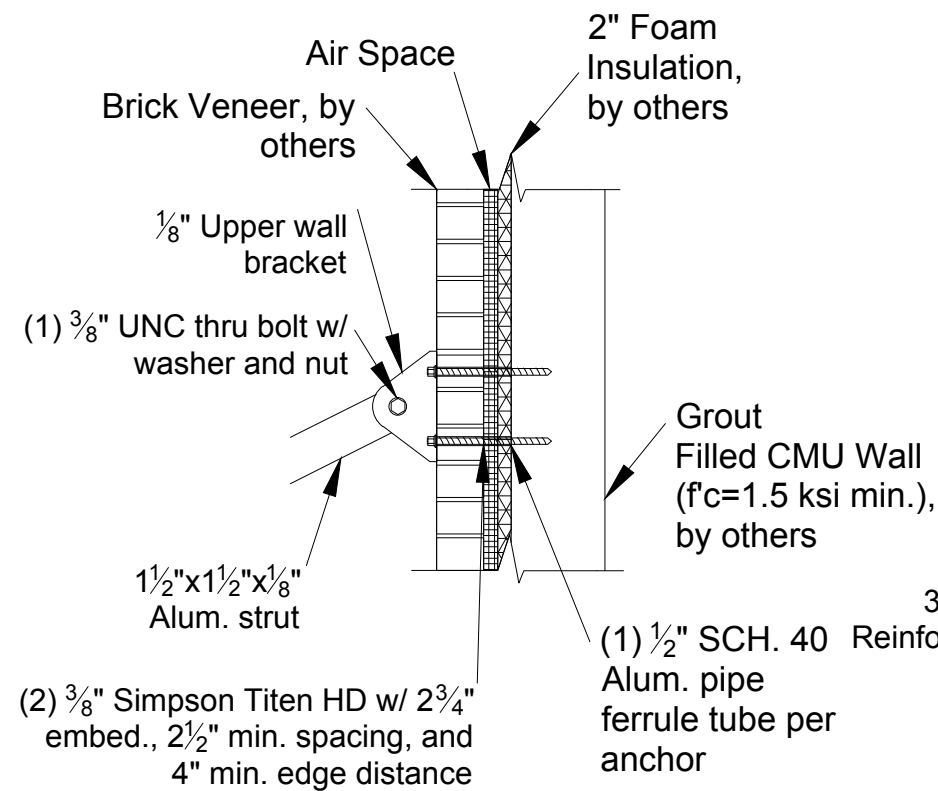

2/11 Wall Bracket Detail

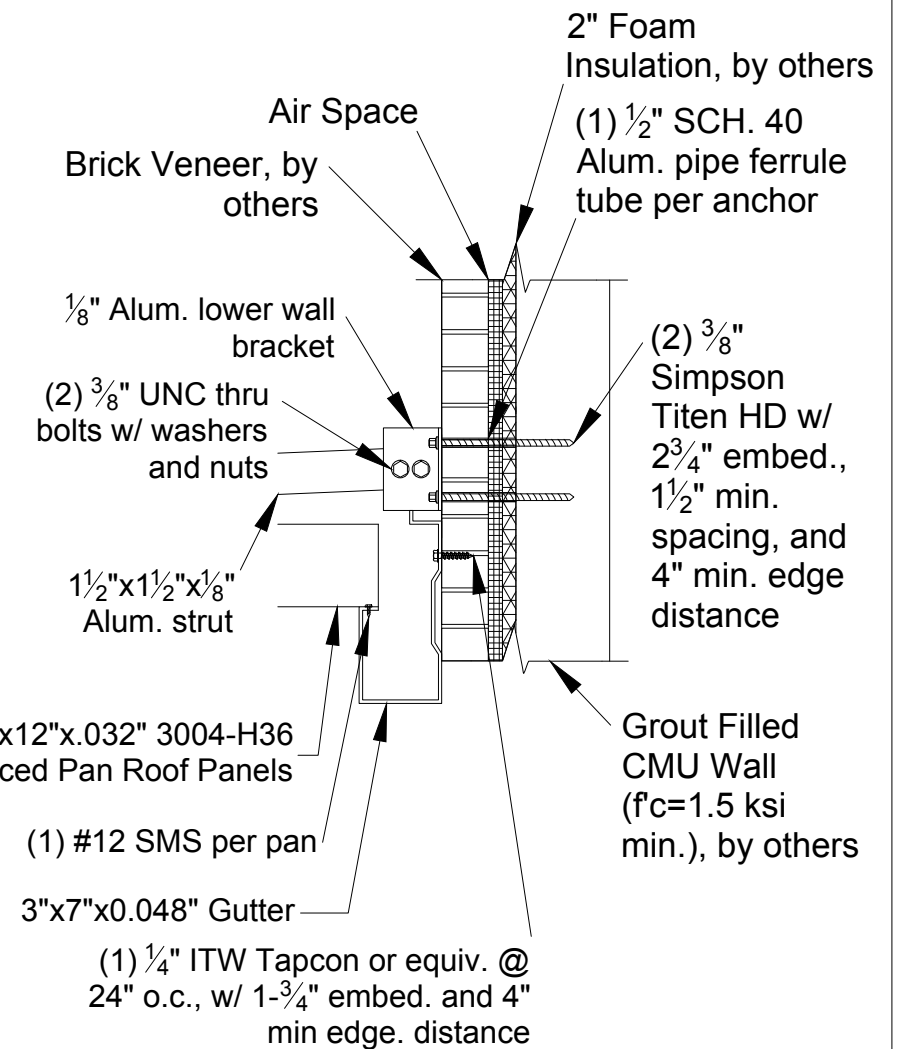

3/11 Rear Gutter Detail



GHRC-100

SCALE:N/A	APPROVED BY:	DRAWN BY: ES
DATE: 4/23/19		REVISION:
FOR:		Drawing Number: 11 of 13

THESE DRAWINGS WERE PREPARED BY AND ARE THE SOLE PROPERTY OF GREENVILLE AWNING COMPANY. UNAUTHORIZED USE OR REPRODUCTIONS IS STRICTLY PROHIBITED. GREENVILLE AWNING COMPANY ©

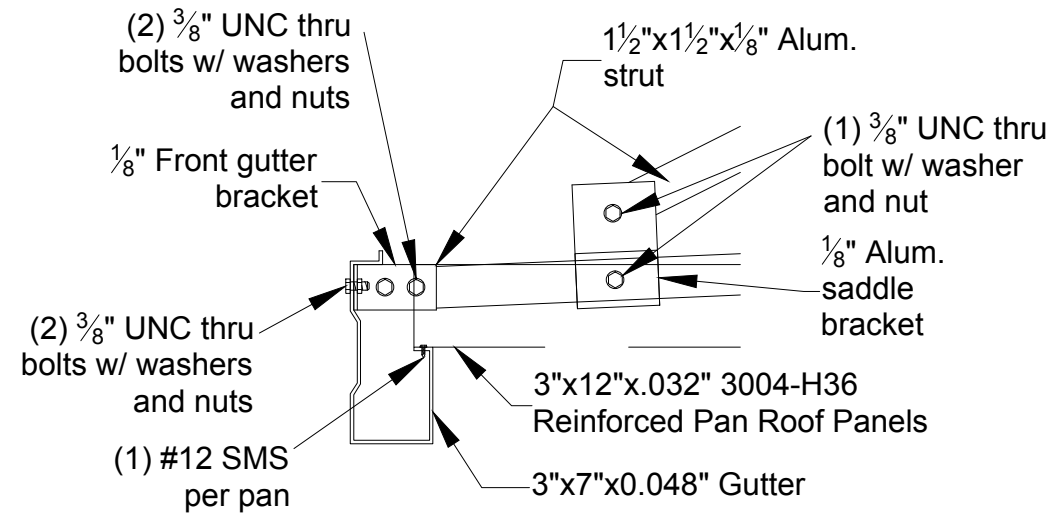

1
12 Front Gutter Detail

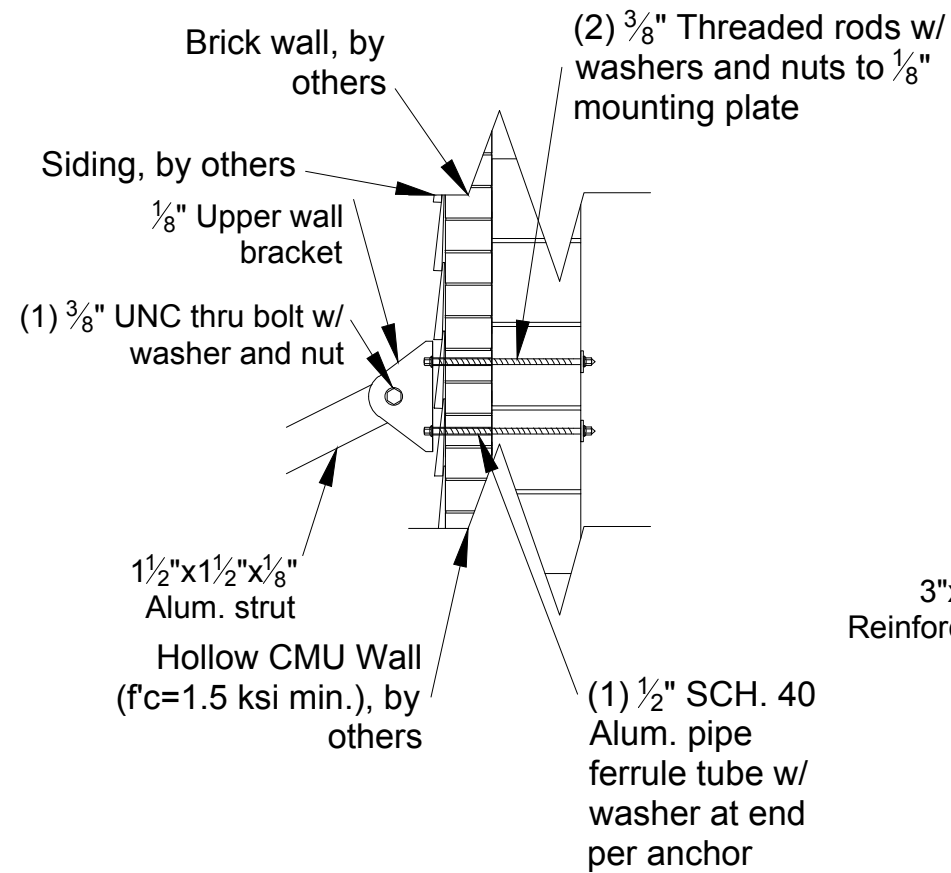

2
12 Wall Bracket Detail

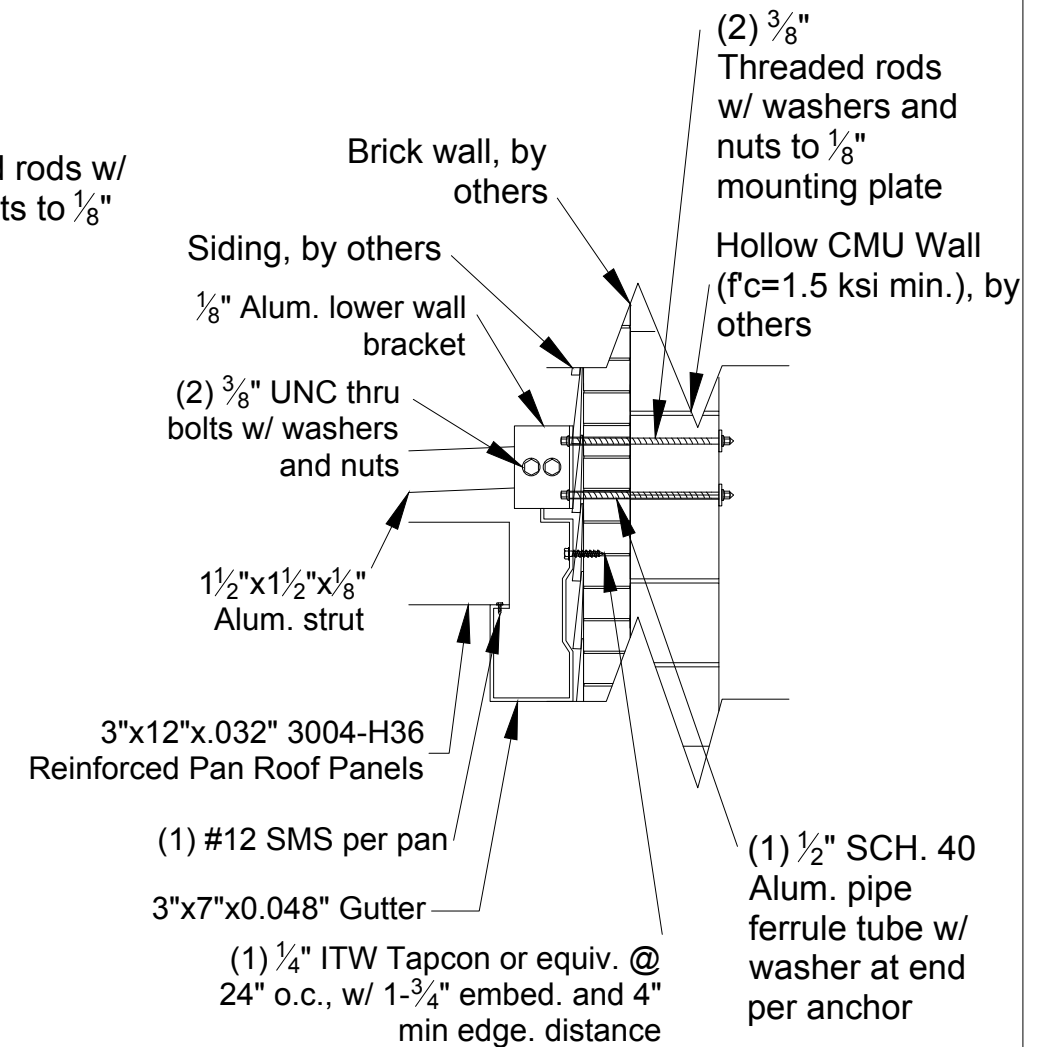

3
12 Rear Gutter Detail



GHRC-100

SCALE:N/A	APPROVED BY:	DRAWN BY: ES
DATE: 4/23/19		REVISION:
FOR:		Drawing Number: 12 of 13

THESE DRAWINGS WERE PREPARED BY AND ARE THE SOLE PROPERTY OF GREENVILLE AWNING COMPANY. UNAUTHORIZED USE OR REPRODUCTIONS IS STRICTLY PROHIBITED. GREENVILLE AWNING COMPANY ©

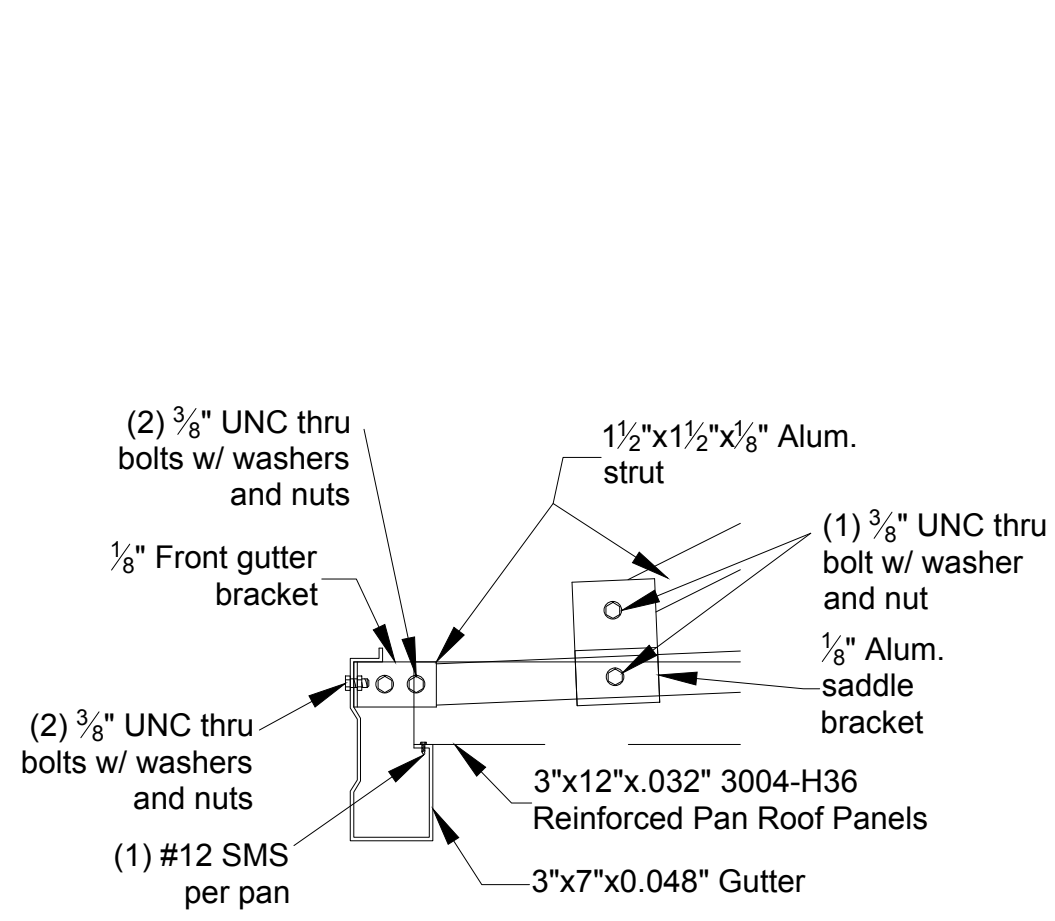

1/13 Front Gutter Detail

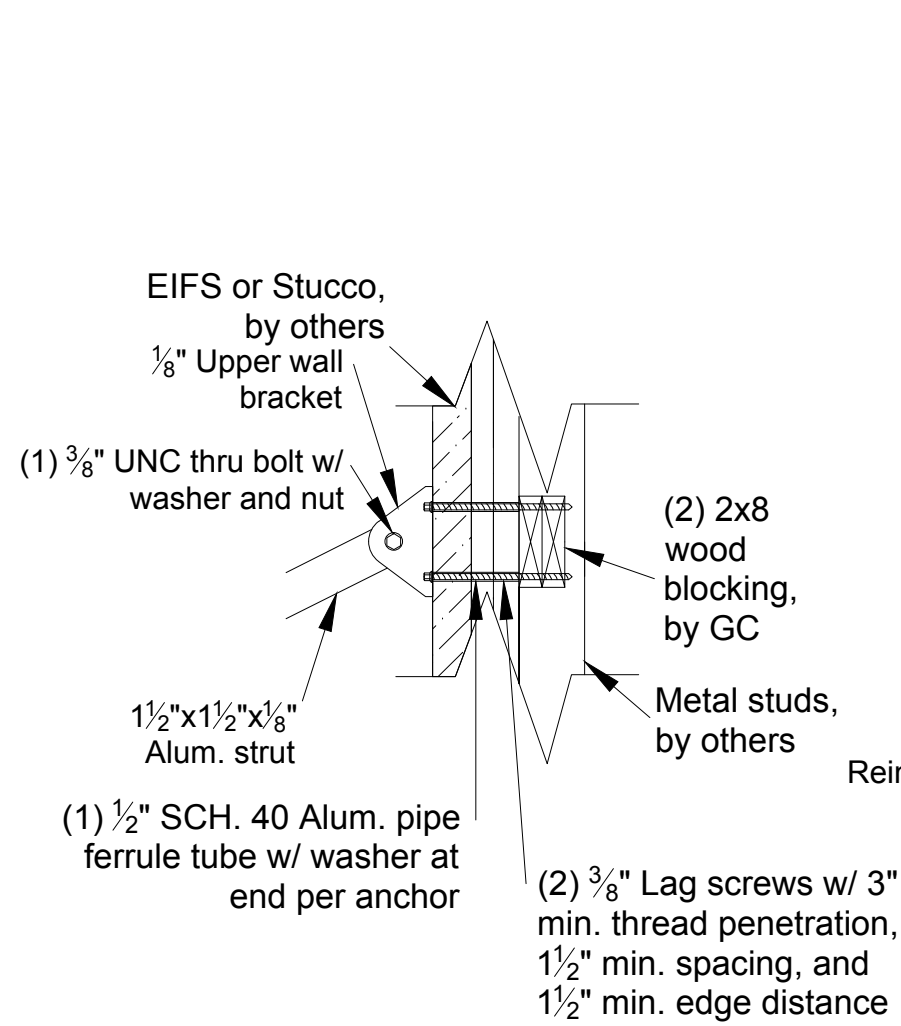

2/13 Wall Bracket Detail

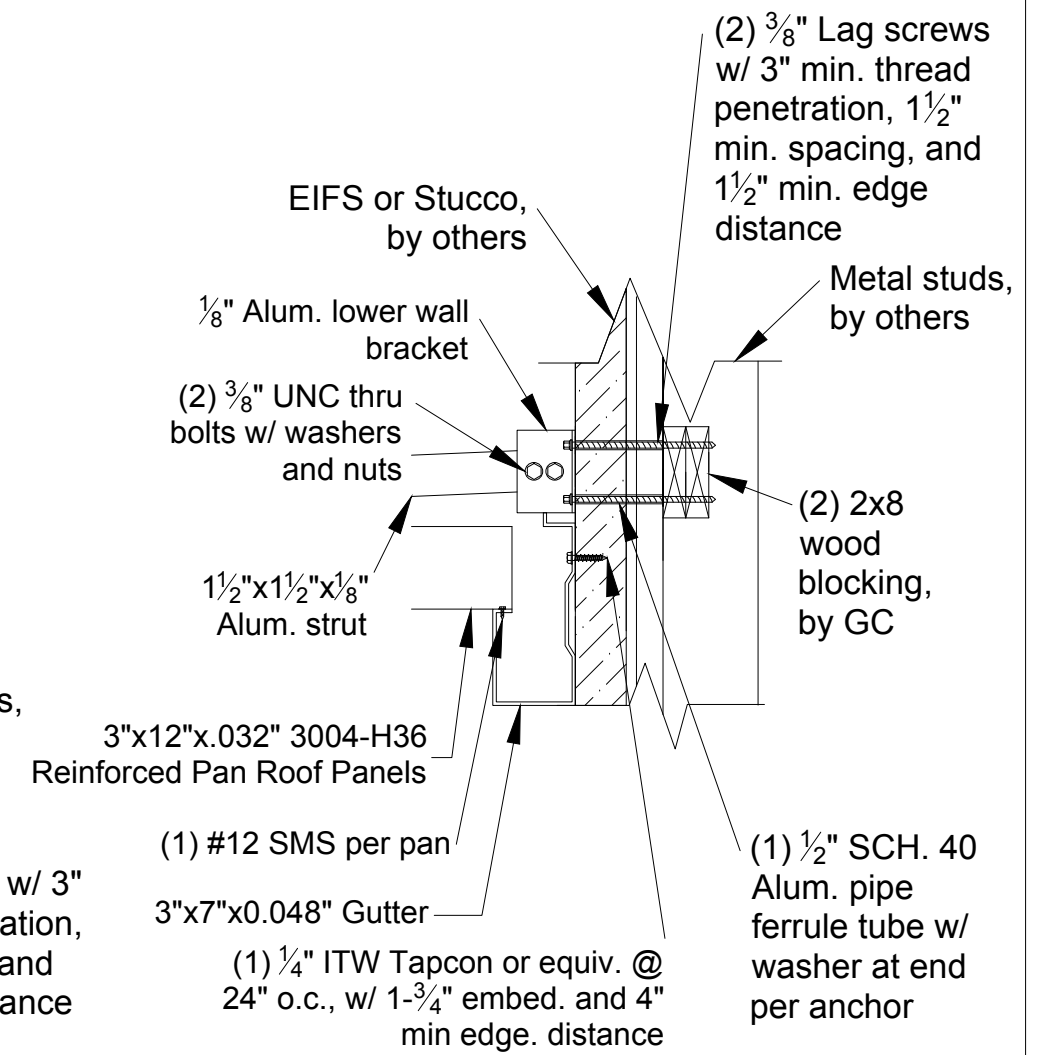

3/13 Rear Gutter Detail



GHRC-100

SCALE:N/A	APPROVED BY:	DRAWN BY: ES
DATE: 4/23/19		REVISION:
FOR:		Drawing Number: 13 of 13

THESE DRAWINGS WERE PREPARED BY AND ARE THE SOLE PROPERTY OF GREENVILLE AWNING COMPANY. UNAUTHORIZED USE OR REPRODUCTIONS IS STRICTLY PROHIBITED. GREENVILLE AWNING COMPANY ©